



Optical sensor modules for Mx-S16A/B*	Thermal sensor module for Mx-S16A/B*	PTMount-Thermal(-TR) for Mx-S16A/B*
PTMount for Mx-S16A/B*	BlockFlexMount for Mx-S16A/B*	BlockFlexMount-CS for Mx-S16A/B*

*Variant Mx-S16B supports MOBOTIX MxBus modules

S16 DualFlex

Quick Install



32.836-005_EN_05/2018

S16 Standard Delivery

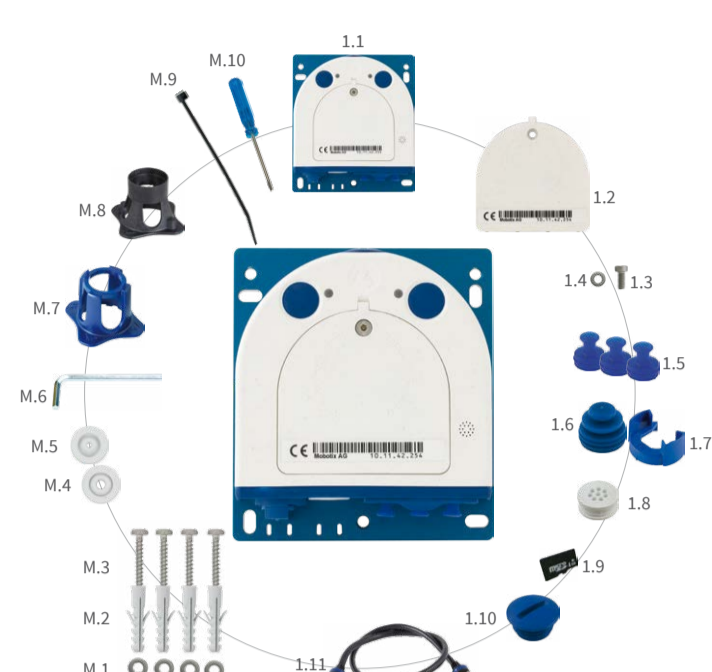

Item	Count	Part Name
M.1	1	S16 Core (base module with base plate)

Item	Count	Part Name
1.2	1	Housing cover for S16 (installed)
1.3	1	Stainless steel Allen screw with flat head M4x8 mm (installed)
1.4	1	Sealing ring (installed)
1.5	3	Sealing plug blue, small (sensor modules, USB, mounted)
1.6	1	Sealing plug blue, large (Ethernet patch cable, mounted)
1.7	1	Cable lock with bayonet catch (Ethernet patch cable, mounted)
1.8	1	Single-wire plug, white (Ethernet installation cable, microphone, speaker, MxBus, installed)
1.9	1	MicroSD card pre-installed (SDHC)
1.10	1	Threaded plug for SD card, blue (mounted)
1.11	1	Ethernet patch cable, 50 cm/19.7 in with sealing

Item	Count	Part Name
M.1	4	Stainless steel washers dia. 4.3 mm
M.2	4	Dowels 6 mm
M.3	4	Stainless steel wood screws with hex head 4x40 mm
M.4	2	Cable plug 5 to 7 mm, white (Ethernet installation cable)
M.5	1	Cable plug 3 to 5 mm, white (Ethernet installation cable)
M.6	1	Allen wrench 2.5 mm
M.7	1	Lens wrench (lens, dome)
M.8	1	Module wrench (sensor module, glass cover/filter insert)
M.9	1	Cable tie (Ethernet installation cable, microphone, speaker, MxBus)
M.10	1	Screwdriver (terminals)

Sensor Modules of the S16 (to Be Ordered Separately)



Installing the Sensor Modules

1. Mounting to a Wall or Ceiling (SMA-S-6D/N/L016 to 500)
 Remove the plastic nut from the sensor module **1**. Remove the bayonet catch and the rubber plug **2**.
 Insert the module into the hole you just drilled (43 mm) **3**.
 Tighten the plastic nut to keep the sensor module safely in place **4**. Push the sensor module cable plug into the connector at the back of the module housing **5**.

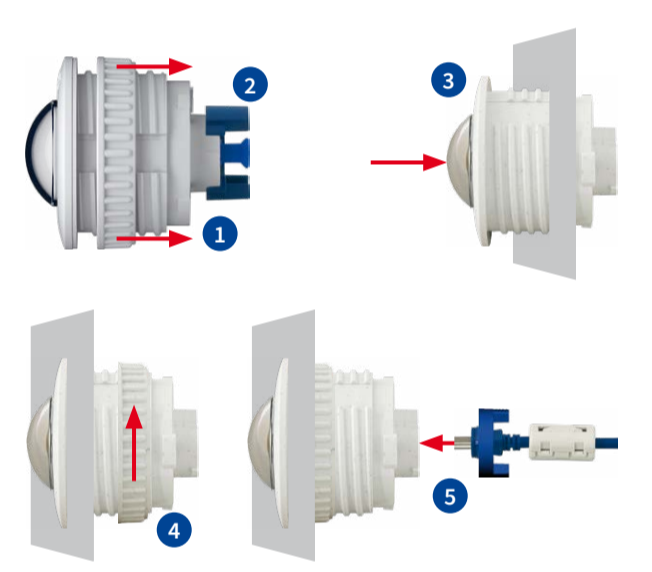

2. Installing a Sensor Module Thermal(-TR)
 For information on installing and the technical specifications, please refer to the separate documentation «Quick Install Sensor Module Thermal(-TR)», which is part of that product delivery.



3. Installing a PTMount-Thermal(-TR)
 For information on installing and the technical specifications, please refer to the separate documentation «Quick Install PTMount-Thermal(-TR)», which is part of that product delivery.



Mounting the Camera

Installation Using the Base Plate
 Attach the camera using the supplied or other screws by affixing the base plate to a suitable material **1** (see «Dimensions/Drilling Template» on page 2).



Connections and Initial Operation of the S16

You can find detailed information on the **installation** and **connections** of the S16 in the S15 Camera Manual (PDF, available on www.mobotix.com > Support > Download Center > Documentation > Manuals).

Please note that the boot options of this camera have changed compared to its predecessor (see «Boot Options of the» on page 2) and the camera only has one key ("L"). Regarding the rest of the **initial operation** of the S16, please see the S15 Camera Manual in Chapter 3, «Initial Operation». The first access follows the procedure described in the same manual in the section «Initial Operation of the Camera». All other tasks require access to the camera's user interface in the browser. Enter the camera's IP address into the address bar of the browser (user "admin", password "meinsm"; password must be changed upon first login – camera software V5.1.x and higher).

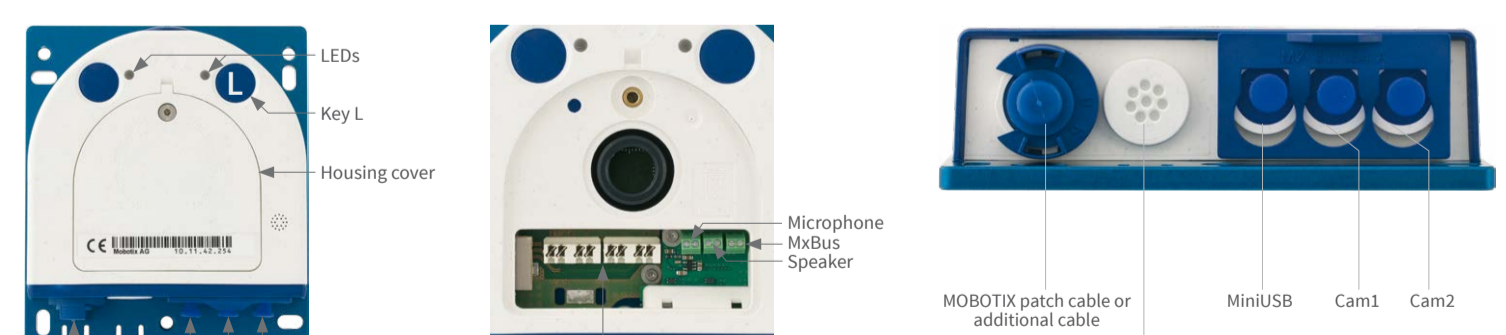

Configuring the Installed Image Sensors

Open **Admin Menu > Hardware Configuration > Image Sensor Configuration** and set the image sensors that are installed as left and right image sensors. If you are using **hemispherical sensor modules with Vandalism domes**, you should open **Admin Menu > Hardware Configuration > Lens Configuration** and activate the corresponding option.

Inserting/Exchanging the SD Card

All camera models can use the integrated MicroSD card (SDHC) to record video data. In order to exchange the MicroSD card, please proceed as outlined in the following instruction. For information on reliable SD cards, please see the MOBOTIX website www.mobotix.com > Support > Download Center > Documentation > White Lists in the document MicroSD Card Whitelist for MOBOTIX Cameras.

When replacing the SD card, make sure that recording has been deactivated in the browser (**Admin Menu > Storage > Storage on External File Server / Flash Device**; activate recording again in the same dialog).



Boot Options of the S16

By default, the camera starts as DHCP client and automatically tries to get an IP address from a DHCP server. To start the camera in a mode different from the default mode, you can activate the boot menu of the camera.

1. Preparing the Camera

- Disconnect the camera's power supply.
- Reconnect the power supply of the camera.

2. Activating the Boot Menu

The red LEDs light up 5 to 10 seconds after establishing the power supply and will stay on for 10 seconds. Briefly press the key L indicated by the red circle in the figure. The camera enters the boot menu, ready for selecting one of the boot options.



The LED now flashes once and repeats the flash signal after pausing for one second (the number of flashes indicates the current boot option). To go to the next boot option, briefly press the key again (< 1 sec). After the last boot option, the camera returns to the first option (LED flashes once).

LED flashes	Boot Option	Meaning	Audio Confirmation*
1 x	Auto Configuration	Starts the auto configuration in order to operate this camera as a door station (variant Mx-S16B only, camera software V5.2.x and higher, 2nd half of 2018).	Phone ringing
2 x	Factory Defaults	Starts the camera with factory defaults (factory default IP address, users and passwords will not be reset).	Boing
3 x	Automatic IP Address	Starts the camera as DHCP client and tries to obtain an IP address from a DHCP server. If a DHCP server cannot be found or no IP address can be obtained, the camera starts with its factory default address.	Boing Boing
4 x	Recovery System	Starts the camera with the recovery system, e.g., in order to recover from a failed update of the camera software.	Alarm Sound

*Only on cameras with audio option and installed speaker.

3. Selecting a Boot Option

Press the key longer (> 2 sec) into the hole. The camera confirms the selection by flashing rapidly three times. After 20 sec, the camera will confirm the selection by playing a sound according to the table above.

If nothing is selected, the camera will resume its normal boot process after a certain time.

Important Notes

Safety Warnings

Notes on Installing:

- This product must not be used in locations exposed to the dangers of explosion. 
- Make sure that you install this product as outlined in Chapter 2, «Installation» of the corresponding manual. A faulty installation can damage the camera!
- When installing this product, make sure that you are only using genuine MOBOTIX parts and MOBOTIX connection cables.
- Only install this product on suitable, solid materials that provide for a sturdy installation of the fixing elements used.

Electrical installation: Electrical systems and equipment may only be installed, modified and maintained by a qualified electrician or under the direction and supervision of a qualified electrician in accordance with the applicable electrical guidelines. Make sure to properly set up all electrical connections. 

Electrical surges: MOBOTIX cameras are protected against the effects of small electrical surges by numerous measures. These measures, however, cannot prevent the camera from being damaged when stronger electrical surges occur. Special care should be taken when installing the camera outside of buildings to ensure proper protection against **lightning**, since this also protects the building and the whole network infrastructure. 

Max. power consumption of attached extension modules: The power consumption of all attached **MxBus modules must not exceed 3 W**. When attaching modules to the MxBus connector **and** the USB socket, the **power consumption of all attached modules must not exceed 4 W, if the camera is powered by PoE class 3**. If **PoE class 2** is used, **the power consumption of all attached modules must not exceed 1 W!** 

Never touch the lenses: Due to the high performance of the S16, the area of the image sensor **can get quite hot**, especially when the ambient temperature is also high. This does not affect the proper functioning of the camera in any way. For this reason, the product must not be installed within the reach of persons without domes or protective lens covers mounted on the sensor modules. 

Power off before opening the camera or exchanging sensor modules: Make sure the power supply to the camera is disconnected before opening the camera housing (e.g., when exchanging the SD card) or when installing or exchanging sensor modules. 

Network security: MOBOTIX products include all of the necessary configuration options for operation in Ethernet networks in compliance with data protection laws. The operator is responsible for the data protection concept across the entire system. 

The basic settings required to prevent misuse can be configured in the software and are password-protected. This prevents unauthorized parties from accessing these settings.

Attention – Special Export Laws Apply!

Cameras with thermal image sensors ("thermal cameras") are subject to the special export regulations of the U.S.A. and the ITAR (International Traffic in Arms Regulation): 

- According to the currently applicable export regulations of the U.S.A. and the ITAR, cameras with thermal image sensors or parts thereof must not be exported to countries embargoed by the U.S.A. or the ITAR. At present, this applies to the following countries: Syria, Iran, Cuba, North Korea and Sudan. The same export ban applies to all persons and institutions listed in "The Denied Persons List" (see www.bis.doc.gov > Policy Guidance > Lists of Parties of Concern).
- Under no circumstances must the camera itself or its thermal image sensors be used in the design, the development or in the production of nuclear, biological or chemical weapons or in the weapons themselves.

Legal Notes

Legal aspects of video and sound recording: You must comply with all data protection regulations for video and sound monitoring when using MOBOTIX products. Depending on national laws and the installation location of the S16, the recording of video and sound data may be subject to special documentation or it may be prohibited. All users of MOBOTIX products are therefore required to familiarize themselves with all applicable regulations and to comply with these laws. MOBOTIX AG is not liable for any illegal use of its products. 

Disposal

Electrical and electronic products contain many valuable materials. For this reason, we recommend that you dispose of MOBOTIX products at the end of their service life in accordance with all legal requirements and regulations (or deposit these products at a municipal collection center). MOBOTIX products must not be disposed of in household waste! If the product contains a battery, please dispose of the battery separately (the corresponding product manuals contain specific directions if the product contains a battery). 

Disclaimer

MOBOTIX AG does not assume any responsibility for damages, which are the result of improper use or failure to comply to the manuals or the applicable rules and regulations. Our **General Terms and Conditions** apply. You can download the current version of the General Terms and Conditions from our website at www.mobotix.com by clicking on the **COS** link at the bottom of every page. 

Technical Specifications S16

Model Versions	Mx-S16A/B* (any combination of Day/Night/Thermal/Thermal-TR sensor modules) *Variant Mx-S16B supports MOBOTIX MxBus modules
Lens Options Mx Sensor Module	10 to 270 mm (35 mm format), hor. angles of view 180° to 8° (6MP)
Lens Options Thermal Image Sensor	43, 65, 135 mm (in 35 mm format), 45°, 25°, 17° horizontal angle of view
Sensitivity Mx Sensor Module	Color sensor (6MP): 0.1 Lux at 1/60 s, 0.005 Lux at 1 s Black&White sensor (6MP): 0.02 Lux at 1/60 s, 0.001 Lux at 1/1 s
Sensitivity Thermal Image Sensor	NETD typ. 50 mK, IR range 7.5 to 13.5 µm Range of temperature measuring: -40 to 550 °C/-40 to 1,022 °F Precision Sensor Module Thermal(-TR): ±10 K of the thermal radiation received at the sensor
Image Sensor Mx Sensor Module	1/1.8" CMOS, 6MP, progressive scan
Image Sensor Thermal Image Sensor	Uncooled microbolometer, 336x252 pixels
Max. Image Size Mx Sensor Module	Color: 3072x2048 (6MP), 6144x2048 (12MP) Black&White: 3072x2048 (6MP), 6144x2048 (12MP)
Max. Image Size Thermal Image Sensor	Can be scaled up to 3072x2048 (6MP), automatically scaled to size of Mx sensor module
Image Formats (Independent of Type, Per-Sensor Setting)	3072x2048 (6MP), 2592x1944 (5MP), 2048x1536 (QXGA), 1920x1080 (Full-HD), 1280x960 (MEGA), 1280x720 (HD), 1024x768, 800x600, 768x576 (D1-PAL), 704x576 (TV-PAL), 640x480, 384x288, 320x240, 160x120, custom formats
Max. Frame Rate Mx sensor module	MxPEG* (max): 42@HD (1280x720), 34@Full-HD, 24@QXGA, 15@5MP, 12@6MP, 6@2x6MP M-JPEG* (max): 26@HD (1280x720), 13@Full-HD, 9@QXGA, 5@5MP, 4@6MP, 2@2x6MP H.264 (max): 25@Full-HD, 20@QXGA *Single core use only
Max. Frame Rate Thermal Image Sensor	9 fps (when displaying an Mx sensor module and a thermal sensor module, the overall frame rate of the camera is reduced to 9 fps)
Video Codec	MxPEG, M-JPEG, JPEG (max. output size 6MP) H.264 (max. output size QXGA, bandwidth limitation applicable)
ONVIF	ONVIF-S (camera software V5.2.x and higher, 2 nd half of 2018)
Internal DVR	MicroSD card pre-installed (SDHC)
External Video Ring Buffer	Directly on NAS or PC/Server, no additional recording software required
Software (Included)	MxManagementCenter video management software
Image Processing	Backlight compensation, automatic white balance, image distortion correction, panorama correction, video motion detection, MxActivitySensor
Virtual PTZ	Digital pan/tilt/zoom, continuous up to 8X

Alarm/Events	Video Motion detection, MxActivitySensor, external signals, temperature sensor, PIR, microphone, shock detector (with firmware version 5.0.1 and higher), notification via e-mail, FTP, IP telephony (VoIP, SIP), visual/sound alarms, pre- and post-alarm images
Microphone and Speaker	Microphone integrated in optical sensor modules and BlockFlexMount modules (except CS-Mount variants and SMA-S-6D/N/L500); ext. microphone and ext. speaker can be connected
Audio Functions	Lip-synchronous audio, two-way communication, audio recording
Interfaces	Ethernet 100Base-T (patch or installation cable), MiniUSB, MxBus*; inputs/outputs and RS232 via accessories; ext microphone and ext. speaker *Only variant Mx-S16B
Video Telephony	VoIP/SIP, two-way communication, remote controlling using key codes, event notification
Security	User/group management, HTTPS/SSL, IP address filter, IEEE 802.1x, intrusion detection, digital image signature
Certifications	EN55022:2010; EN55024:2010; EN50121-4:2006; EN61000-6-1:2007; EN61000-6-2:2005; EN61000-6-3:2007+A1:2011; EN61000-6-4:2007+A1:2011; AS/NZS CISPR22:2009+A1:2010, CFR47 FCC part15B
Power Supply	Year-round Power-over-Ethernet (IEEE 802.3af); PoE class variable
Operating Conditions	IP66, -30 to 60 °C/-22 to 140 °F, air humidity up to 90-100% (according to EN 50155 Chap. 12.2.5)
Protection Against Mechanical Impact	Mx-S16A/B Body: IK06 (according to IEC 62262/EN 50102)
Power Consumption	Typ. 5W, max. 7W
Power Consumption of External Devices	At MxBus: max. 3W, at USB: max. 2.5W, total max. 4W The power consumption of the camera will increase accordingly!
Dimensions/Weight S16	Width x height x depth: 115 x 130 x 33.5 mm; weight: approx. 430 g (without sensor modules, see below)
Dimensions/Weights Sensor Modules	SMA-S-6D/N/L016: Ø x D: 43 x 45 mm (installation dim.), weight 85 g SMA-S-6D/N/L041/079: Ø x D: 43 x 57 mm (installation dim.), weight 111 g SMA-S-6D/N/L061/119/237: Ø x D: 43 x 60 mm (installation dim.), weight 122 g SMA-S-6D/N/L500: Ø x D: 43 x 60 mm (installation dim.), weight 160 g
Dimensions/Weights Thermal Sensor Modules	See separate product documentation «Quick Install Sensor Module Thermal(-TR)»
Weight Connection Cable 2 m (per sensor module)	approx. 68 g/0.14 lb
Standard Delivery	Housing (high-resistance composite, PBT), white and base plate aluminum blue anodized, shock-resistant dome for SMA-S-6D/N/L016 sensor module, coated glass pane for all other sensor modules, protective Germanium cover for the thermal image sensor, mounting supplies, mounting wrenches, 50 cm/20 in patch cable, software, MicroSD card (SDXC, SDHC installed)

Dimensions/Drilling Template

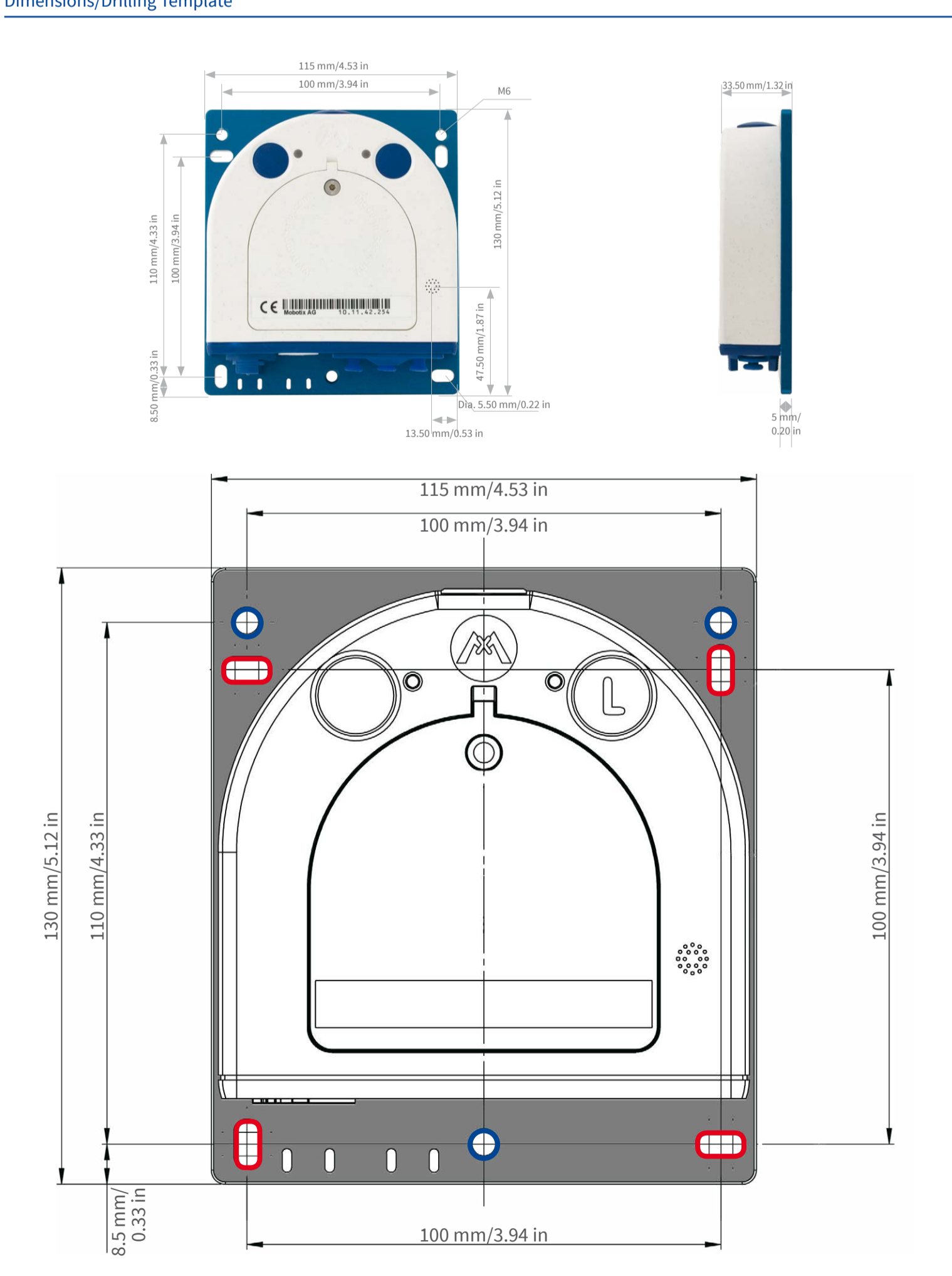

Manuals and drilling templates: www.mobotix.com > Support > Download Center > Documentation > Manuals > S16 DualFlex



Further information on www.mobotix.com:

- Products > Outdoor Cameras > S16 DualFlex
- Support > Download Center > Documentation > Declarations of Conformity

MOBOTIX, the MX Logo, MxPEG and MxActivitySensor are trademarks of MOBOTIX AG registered in the European Union, the U.S.A., and other countries • Information subject to change without notice • MOBOTIX does not assume any liability for technical or editorial errors or omissions contained herein • All rights reserved • © MOBOTIX AG 2017

